

DATA SHEET

150 CLZ

**Aluminum electrolytic capacitors SMD
(Chip)**

**Long life base plate, very low
impedance**

Preliminary specification
Supersedes data of 26th September 2001
File under BCcomponents, BC01

2002 Feb 27

Aluminum electrolytic capacitors SMD (Chip)

Long life base plate, very low impedance

150 CLZ

FEATURES

- Polarized aluminum electrolytic capacitors, non-solid electrolyte, self healing
- SMD-version with base plate, reflow solderable
- Very low impedance, very high ripple current
- Very long useful life: 3000 hours at 105 °C
- Charge and discharge proof, no peak current limitation
- Supplied in blister tape on reel.

APPLICATIONS

- SMD technology, for high mounting density
- Industrial and professional applications
- Automotive, general industrial
- Smoothing, filtering, buffering.

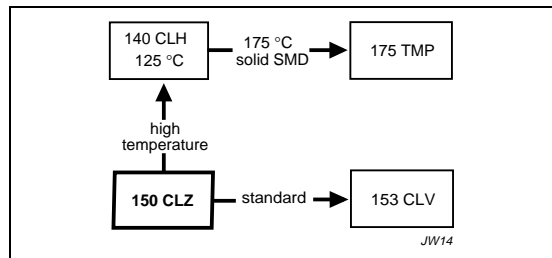
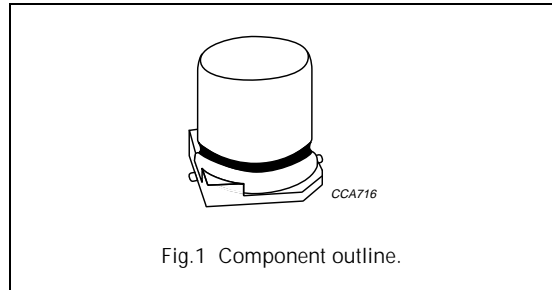

QUICK REFERENCE DATA

DESCRIPTION	VALUE
Nominal case sizes (L × W × H in mm)	8 × 8 × 10 to 10 × 10 × 14
Rated capacitance range, C _R	33 to 1000 μF
Tolerance on C _R	±20%
Rated voltage range, U _R	6.3 to 63 V
Category temperature range	-55 to +105 °C
Endurance test at 105 °C:	2000 hours
Useful life at 105 °C:	
case size ≤10 × 10 × 10	2500 hours
case size 10 × 10 × 14	3000 hours
Useful life at 40 °C; 1.8 × I _R applied:	
case size ≤10 × 10 × 10	125000 hours
case size 10 × 10 × 14	150000 hours
Shelf life at 0 V, 105 °C	1000 hours
Based on sectional specification	IEC 60384-18/CECC32300
Climatic category IEC 60068	55/105/56

Aluminum electrolytic capacitors SMD (Chip)

Long life base plate, very low impedance

150 CLZ

Selection chart for C_R , U_R and relevant nominal case sizes ($L \times W \times H$ in mm)

Preferred types in **bold**.

C_R (μF)	U_R (V)						
	6.3	10	16	25	35	50	63
33	–	–	–	–	–	–	8 × 8 × 10
47	–	–	–	–	–	–	8 × 8 × 10
	–	–	–	–	–	–	10 × 10 × 10
68	–	–	–	–	–	8 × 8 × 10	10 × 10 × 10
100	–	–	–	–	8 × 8 × 10	10 × 10 × 10	10 × 10 × 14
150	–	–	–	8 × 8 × 10	–	–	–
220	–	–	8 × 8 × 10	8 × 8 × 10	10 × 10 × 10	10 × 10 × 14	–
330	–	8 × 8 × 10	8 × 8 × 10	10 × 10 × 10	10 × 10 × 14	–	–
470	8 × 8 × 10	8 × 8 × 10	10 × 10 × 10	10 × 10 × 14	–	–	–
680	–	10 × 10 × 10	10 × 10 × 14	–	–	–	–
1000	10 × 10 × 10	10 × 10 × 14	–	–	–	–	–

MARKING

- Rated capacitance (in μF)
- Rated voltage (in V)
- Black mark or ‘–’ sign indicating the cathode (the anode is identified by bevelled edges)
- Code indicating group number (Z)
- Date code, in accordance with “IEC 60062”.

Aluminum electrolytic capacitors SMD (Chip)

Long life base plate, very low impedance

150 CLZ

MECHANICAL DATA

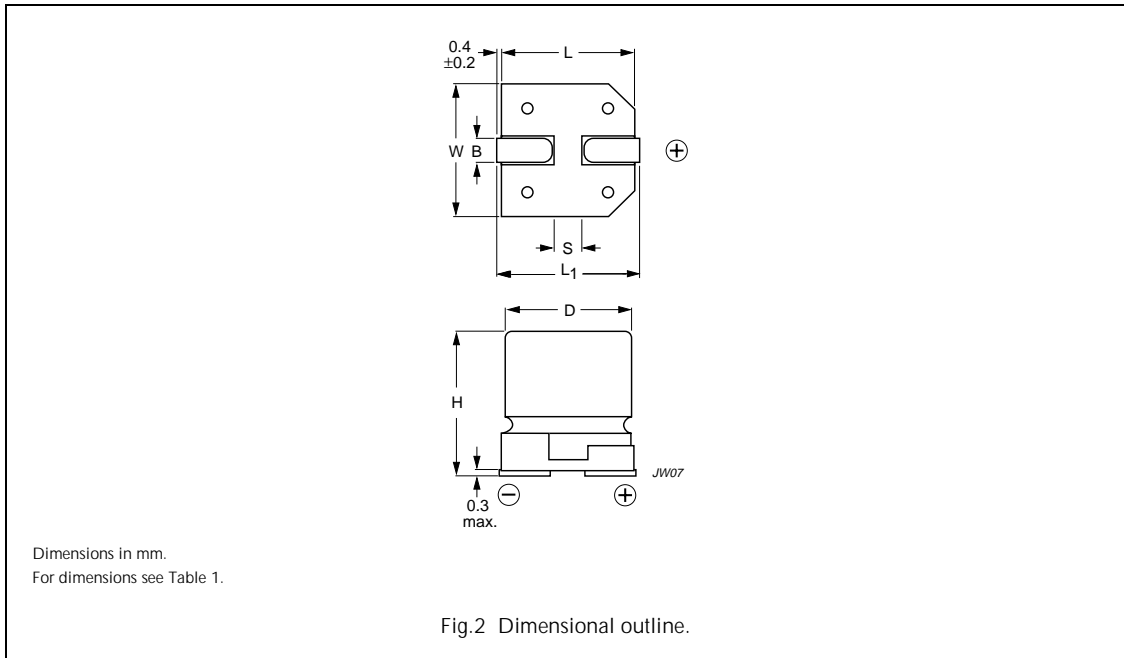

Table 1 Physical dimensions, mass and packaging quantities; see Fig.2

NOMINAL CASE SIZE L × W × H (mm)	CASE CODE	L _{max} (mm)	W _{max} (mm)	H _{max} (mm)	∅D (mm)	B _{max} (mm)	S (mm)	L _{1 max} (mm)	MASS (g)
8 × 8 × 10	0810	8.5	8.5	10.5	8.0	1.0	3.1	9.9	≈1.0
10 × 10 × 10	1010	10.5	10.5	10.5	10.0	1.0	4.5	11.8	≈1.3
10 × 10 × 14	1014	10.5	10.5	14.3	10.0	1.0	4.5	11.8	≈1.5

PACKAGING

Supplied in blister tape on reel. For general packaging information refer to data handbook BC01, section “Packaging”.

Table 2 Tape and reel dimensions

NOMINAL CASE SIZE L × W × H (mm)	CASE CODE	PITCH P ₁ (mm)	TAPE WIDTH W (mm)	TAPE THICKNESS T ₂ (mm)	REEL DIA. (mm)	PACKAGING QUANTITY PER REEL
8 × 8 × 10	0810	16	24	11.8	380	500
10 × 10 × 10	1010	16	24	11.8	380	500
10 × 10 × 14	1014	16	24	15.0	330	250

Aluminum electrolytic capacitors SMD (Chip)

Long life base plate, very low impedance

150 CLZ

MOUNTING

The capacitors are designed for automatic placement on to printed-circuit boards.

Optimum dimensions of soldering pads depend amongst others on soldering method, mounting accuracy, print lay-out and/or adjacent components.

For recommended soldering pad dimensions, refer to Fig.3 and Table 3

Soldering

Soldering conditions are defined by the curve, temperature versus time, where the temperature is that measured on the soldering pad during processing.

For maximum conditions refer to Fig.4.

Any temperature versus time curve which does not exceed the specified maximum curves may be applied.

AS A GENERAL PRINCIPLE, TEMPERATURE AND DURATION SHALL BE THE **MINIMUM** NECESSARY REQUIRED TO ENSURE GOOD SOLDERING CONNECTIONS. HOWEVER, THE SPECIFIED MAXIMUM CURVES SHOULD NEVER BE EXCEEDED.

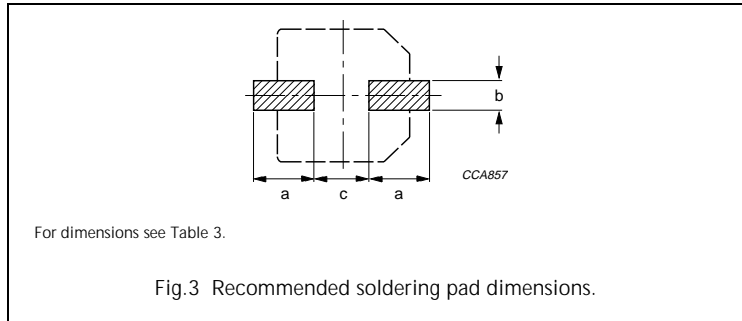
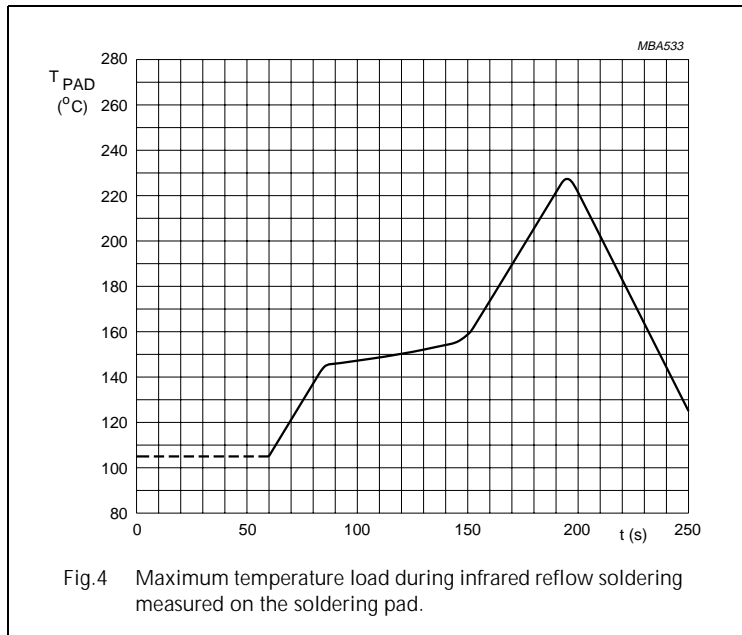

Table 3 Recommended soldering pad dimensions; see Fig.3

CASE CODE	a (mm)	b (mm)	c (mm)
0810	3.5	2.5	3.0
1010	4.3	2.5	4.0
1014	4.3	2.5	4.0



Aluminum electrolytic capacitors SMD (Chip)

Long life base plate, very low impedance

150 CLZ

ELECTRICAL DATA AND ORDERING INFORMATION

Unless otherwise specified, all electrical values in Table 4 apply at $T_{amb} = 20\text{ °C}$,
 $P = 86$ to 106 kPa , $RH = 45$ to 75% .

Electrolytic capacitor 150 CLZ series

220 $\mu\text{F}/50\text{ V}$; $\pm 20\%$

Nominal case size:

10 × 10 × 14 mm; taped on reel

Catalogue number: 2222 150 95102.

SYMBOL	DESCRIPTION
C_R	rated capacitance at 100 Hz, tolerance $\pm 20\%$
I_R	rated RMS ripple current at 100 kHz, 105 °C
I_{L2}	max. leakage current after 2 minutes at U_R
Tan δ	max. dissipation factor at 100 Hz
Z	max. impedance at 100 kHz

Ordering example

Table 4 Electrical data and ordering information; preferred types in **bold**

U_R (V)	C_R (μF)	NOMINAL CASE SIZE L × W × H (mm)	I_R 105 °C (mA) 100 kHz	I_{L2} 2 min (μA)	Tan δ 100 Hz	Z 100 kHz +20 °C (Ω)	CATALOGUE NUMBER 2222 150
6.3	470	8 × 8 × 10	435	30	0.24	0.25	95311
	1000	10 × 10 × 10	670	63	0.24	0.13	95301
10	330	8 × 8 × 10	435	33	0.20	0.25	95411
	470	8 × 8 × 10	435	47	0.20	0.25	95412
	680	10 × 10 × 10	670	68	0.20	0.13	95401
	1000	10 × 10 × 14	850	100	0.20	0.10	95402
16	220	8 × 8 × 10	435	35	0.16	0.25	95511
	330	8 × 8 × 10	435	53	0.16	0.25	95512
	470	10 × 10 × 10	670	75	0.16	0.13	95501
	680	10 × 10 × 14	850	109	0.16	0.10	95502
25	150	8 × 8 × 10	420	38	0.14	0.28	95611
	220	8 × 8 × 10	420	55	0.14	0.28	95612
	330	10 × 10 × 10	640	83	0.14	0.14	95601
	470	10 × 10 × 14	820	118	0.14	0.11	95602
35	100	8 × 8 × 10	405	35	0.12	0.30	95011
	220	10 × 10 × 10	630	77	0.12	0.15	95001
	330	10 × 10 × 14	790	116	0.12	0.12	95002
50	68	8 × 8 × 10	333	34	0.12	0.48	95111
	100	10 × 10 × 10	490	50	0.12	0.24	95101
	220	10 × 10 × 14	620	110	0.12	0.19	95102
63	33	8 × 8 × 10	270	21	0.10	0.65	95812
	47	8 × 8 × 10	270	30	0.10	0.65	95811
	47	10 × 10 × 10	390	30	0.10	0.38	95801
	68	10 × 10 × 10	390	43	0.10	0.38	95802
	100	10 × 10 × 14	507	63	0.10	0.29	95803

Aluminum electrolytic capacitors SMD (Chip)

Long life base plate, very low impedance

150 CLZ

Additional electrical data

PARAMETER	CONDITIONS	VALUE
Voltage		
Surge voltage for short periods	IEC 60384-18, subclause 4.14	$U_S \leq 1.15 \times U_R$
Reverse voltage for short periods	IEC 60384-18, subclause 4.16	$U_{rev} \leq 1 \text{ V}$
Current		
Leakage current	after 2 minutes at U_R	$I_{L2} \leq 0.01 \times C_R \times U_R$
Inductance		
Equivalent series inductance (ESL)		typ. 16 nH
Resistance		
Equivalent series resistance (ESR) at 100 Hz	calculated from $\tan \delta_{max}$ and C_R (see Table 4)	$ESR = \tan \delta / 2\pi f C_R$

Capacitance (C)

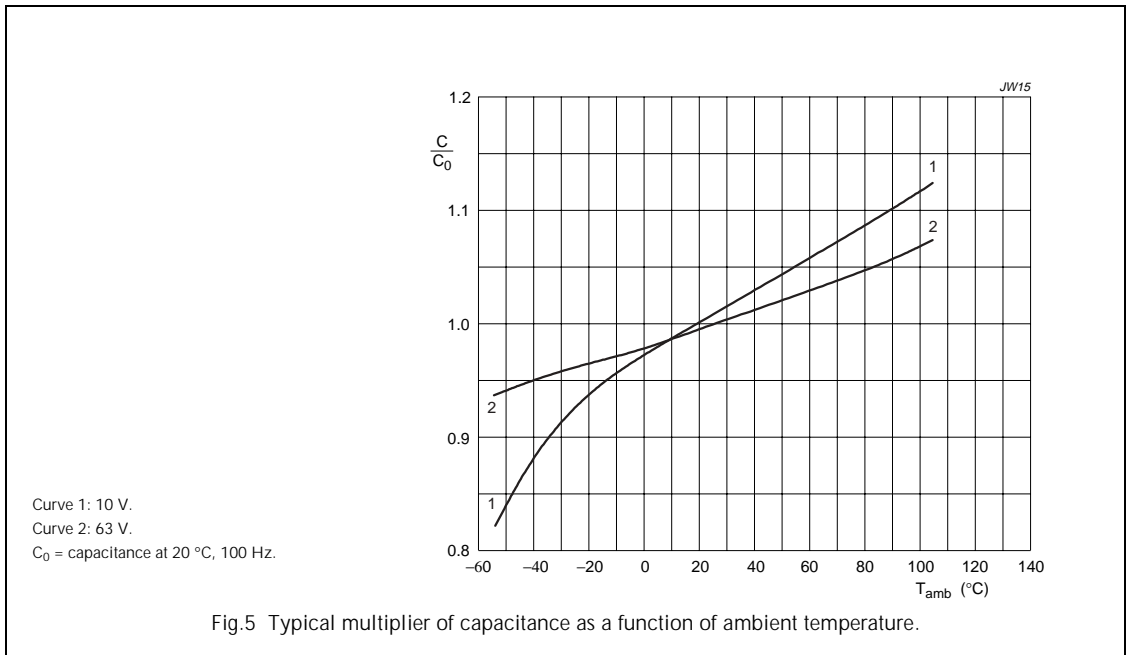

Fig.5 Typical multiplier of capacitance as a function of ambient temperature.

Aluminum electrolytic capacitors SMD (Chip)

Long life base plate, very low impedance

150 CLZ

Dissipation factor ($\tan \delta$)

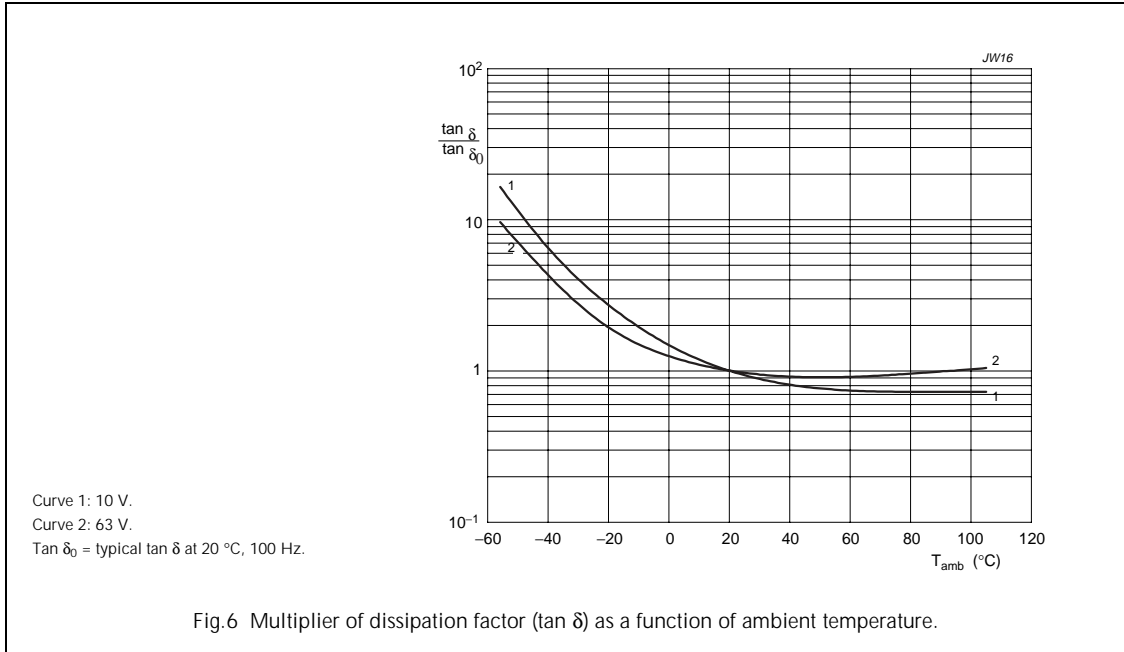

Equivalent series resistance (ESR)

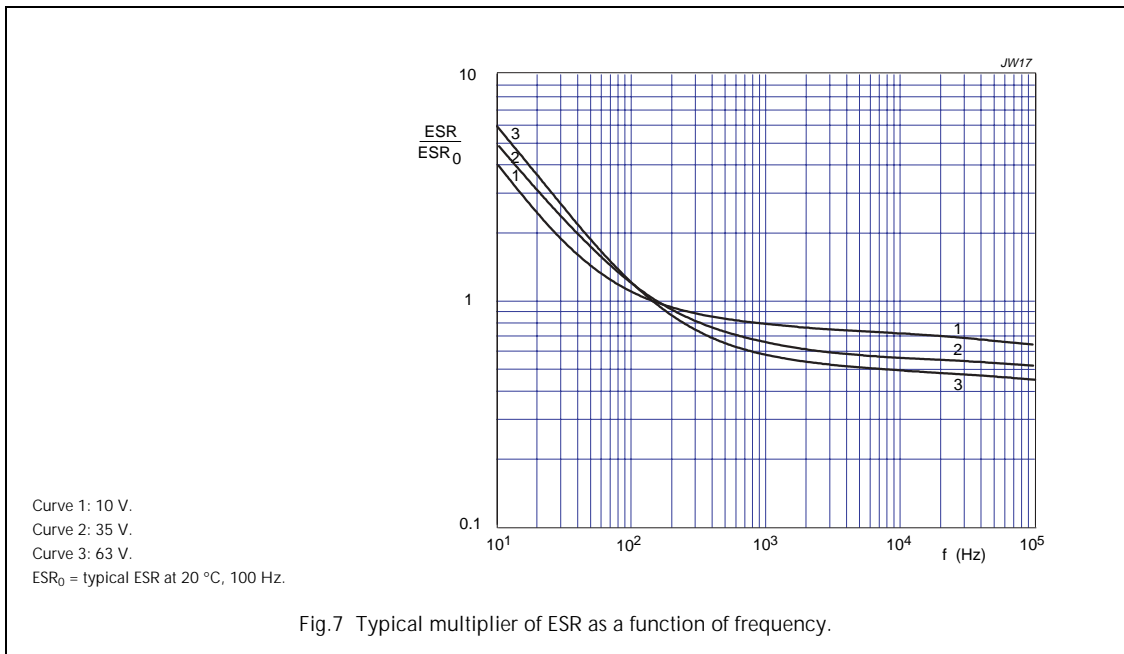

Aluminum electrolytic capacitors SMD (Chip)

Long life base plate, very low impedance

150 CLZ

Impedance (Z)

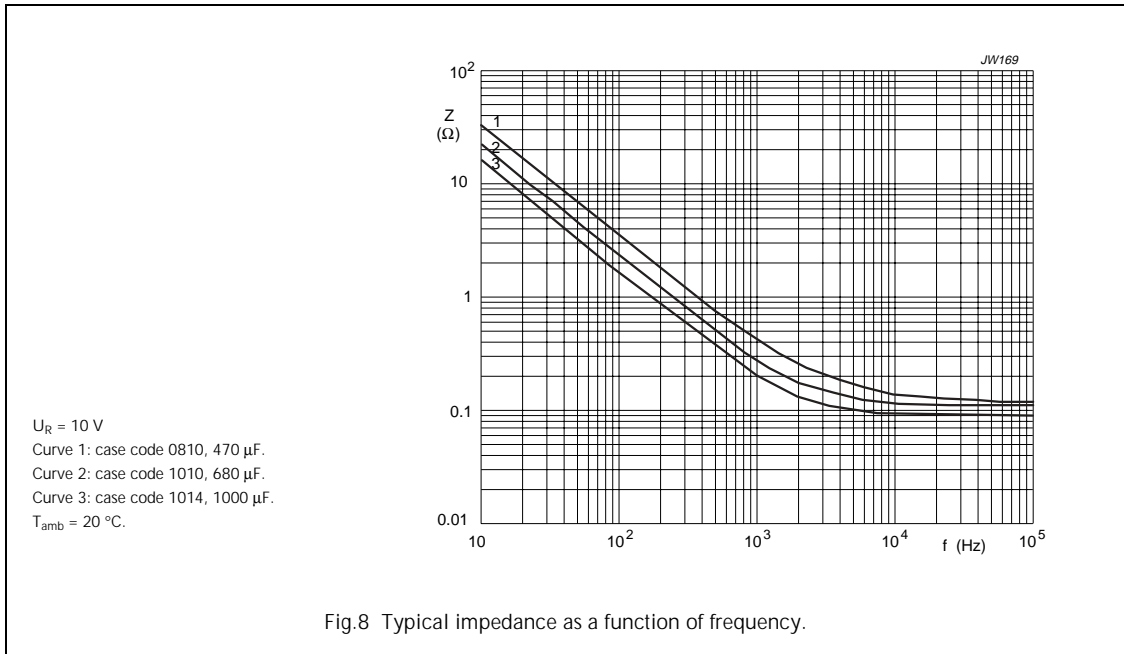

Fig.8 Typical impedance as a function of frequency.

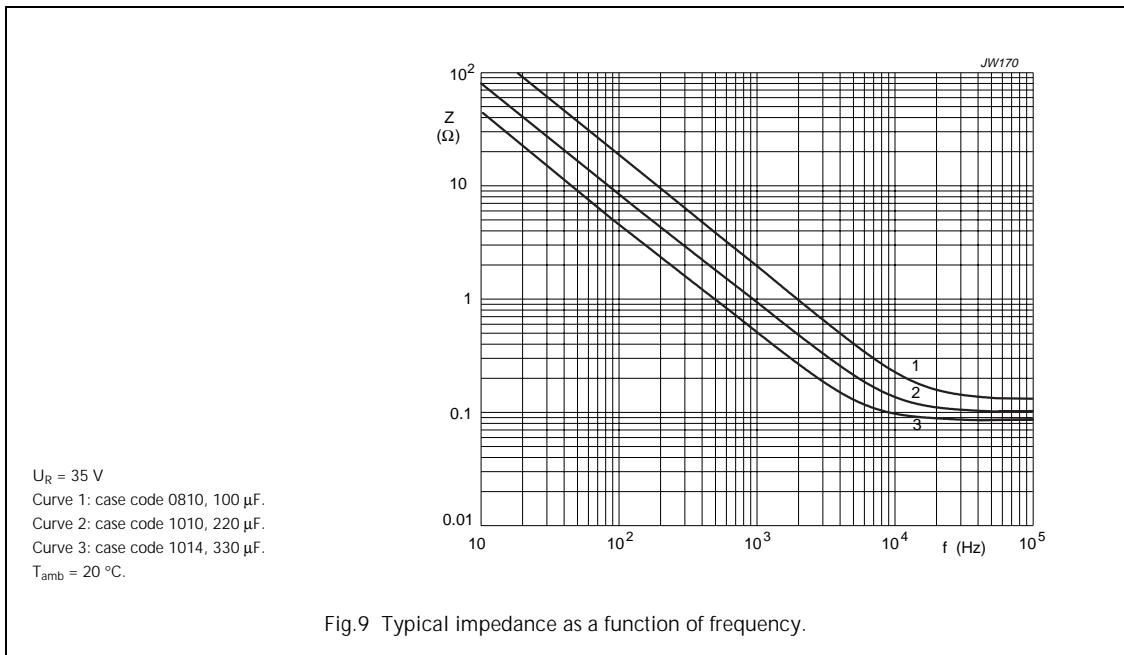
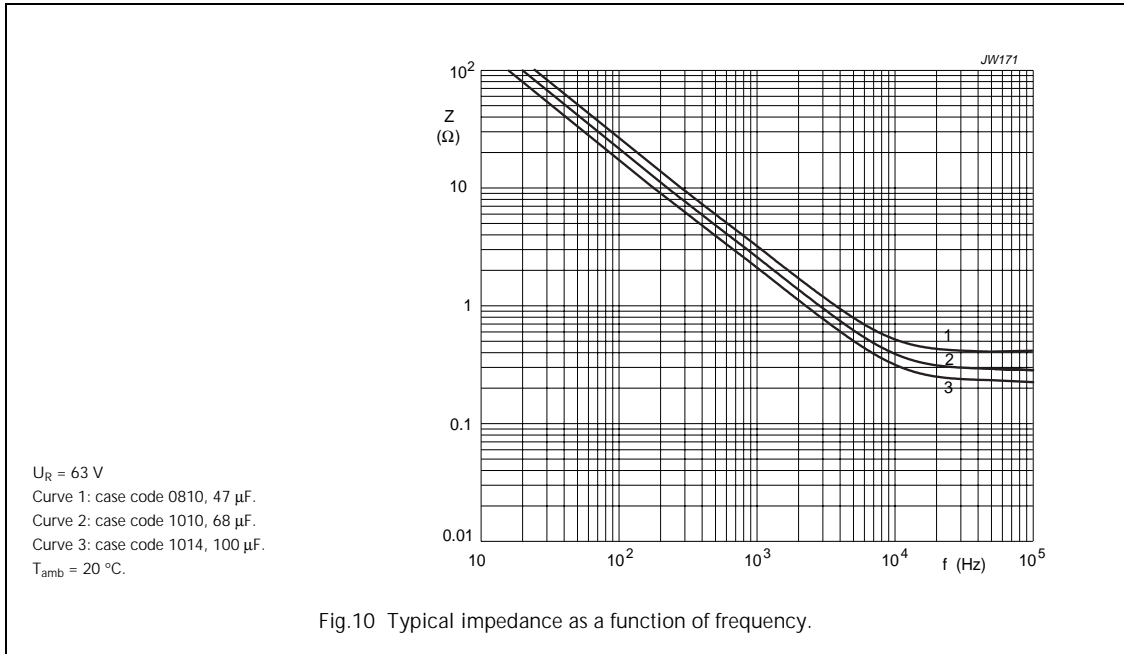

Fig.9 Typical impedance as a function of frequency.

Aluminum electrolytic capacitors SMD (Chip)

Long life base plate, very low impedance

150 CLZ



RIPPLE CURRENT AND USEFUL LIFE

Table 5 Multiplier of ripple current (I_R) as a function of frequency

FREQUENCY (Hz)	I_R MULTIPLIER		
	$U_R = 6.3\text{ to }25\text{ V}$	$U_R = 35\text{ V}$	$U_R = 50\text{ to }63\text{ V}$
100	0.70	0.65	0.60
300	0.80	0.80	0.75
1000	0.85	0.85	0.85
3000	0.93	0.93	0.93
10000	0.95	0.95	0.95
30000	0.97	0.97	0.97
100000	1.00	1.00	1.00

Aluminum electrolytic capacitors SMD (Chip)

Long life base plate, very low impedance

150 CLZ

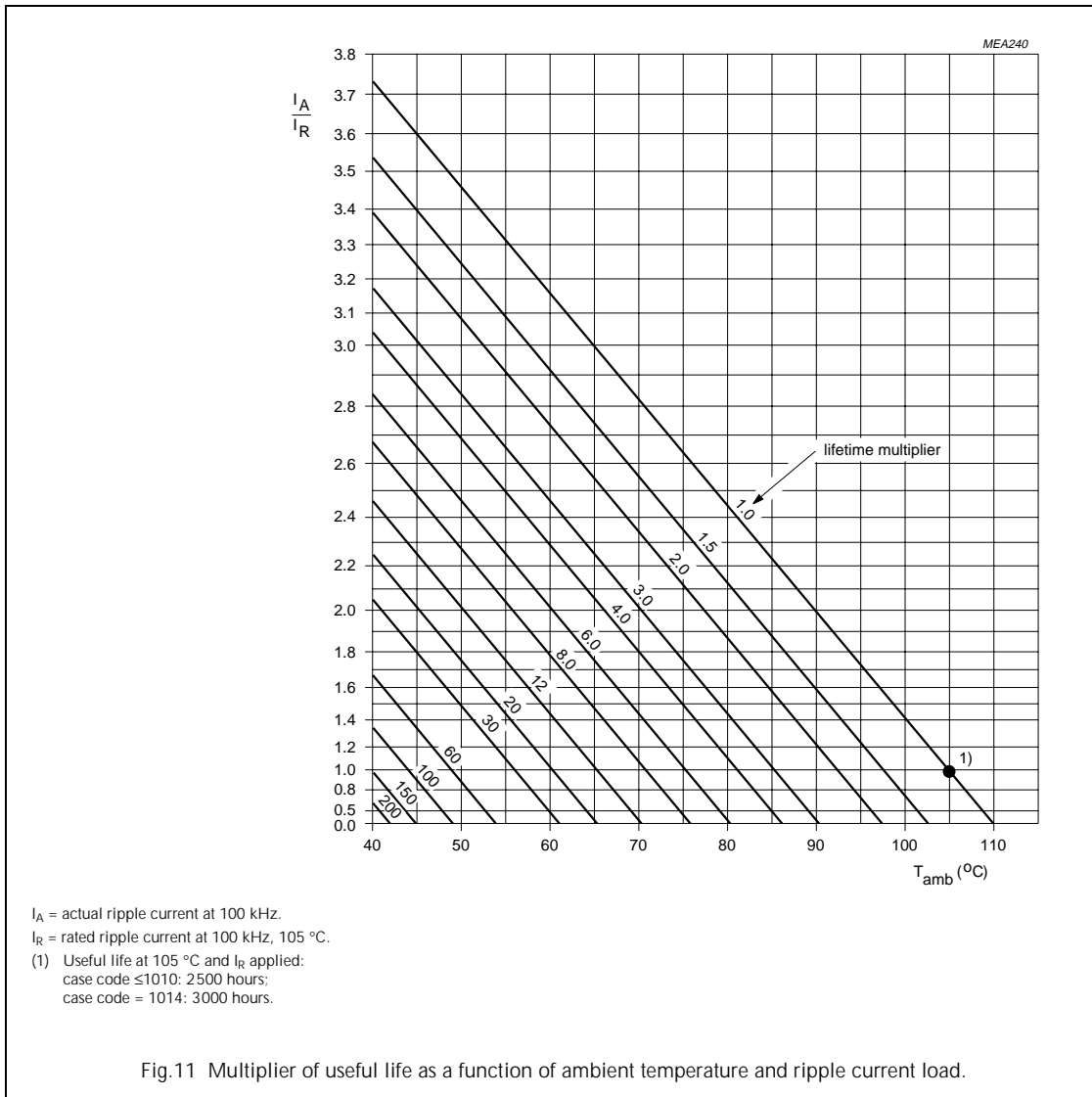

Fig.11 Multiplier of useful life as a function of ambient temperature and ripple current load.

Aluminum electrolytic capacitors SMD (Chip)

Long life base plate, very low impedance

150 CLZ

SPECIFIC TESTS AND REQUIREMENTS

General tests and requirements are specified in data handbook BC01, section "Tests and Requirements".

Table 6 Test procedures and requirements

TEST		PROCEDURE (quick reference)	REQUIREMENTS
NAME OF TEST	REFERENCE		
Mounting	IEC 60384-18, subclause 4.3	shall be performed prior to tests mentioned below; reflow soldering; for maximum temperature load refer to chapter "Mounting"	$\Delta C/C: \pm 5\%$ $\tan \delta \leq \text{spec. limit}$ $I_{L2} \leq \text{spec. limit}$
Endurance	IEC 60384-18/ CECC32300, subclause 4.15	$T_{\text{amb}} = 105 \text{ }^\circ\text{C}$; U_R applied; 2000 hours	$U_R = 6.3 \text{ V}$; $\Delta C/C: \pm 25\%$ $U_R \geq 10 \text{ V}$; $\Delta C/C: \pm 20\%$ $\tan \delta \leq 2 \times \text{spec. limit}$ $I_{L2} \leq \text{spec. limit}$
Useful life	CECC 30301, subclause 1.8.1	$T_{\text{amb}} = 105 \text{ }^\circ\text{C}$; U_R and I_R applied; case size $\leq 10 \times 10 \times 10$: 2 500 hours case size = $10 \times 10 \times 14$: 3 000 hours,	$\Delta C/C: \pm 50\%$ $\tan \delta \leq 3 \times \text{spec. limit}$ $I_{L2} \leq \text{spec. limit}$ no short or open circuit total failure percentage: $\leq 1\%$
Shelf life (storage at high temperature)	IEC 60384-18/ CECC32300, subclause 4.17	$T_{\text{amb}} = 105 \text{ }^\circ\text{C}$; no voltage applied; 1 000 hours after test: U_R to be applied for 30 minutes, 24 to 48 hours before measurement	for requirements see 'Endurance test' above